

6223120



Test Booklet No.

ENGLISH

Test Booklet Code

T3

GRIDU

This Booklet contains 32 pages, including Rough Page.
Do not open this Test Booklet until you are asked to do so.

Important Instructions:

- The Answer Sheet is inside this Test Booklet. When you are directed to open the Test Booklet, take out the Answer Sheet and fill in the particulars on ORIGINAL Copy carefully with blue/black ball point pen only.
 - The test is of 3 hours 20 minutes duration and the Test Booklet contains 200 multiple-choice questions (four options with a single correct answer) from Physics, Chemistry and Biology (Botany and Zoology). 50 questions in each subject are divided into two Sections (A and B) as per details given below:
 - Section A shall consist of 35 (Thirty-five) Questions in each subject (Question Nos – 1 to 35, 51 to 85, 101 to 135 and 151 to 185). All questions are compulsory.
 - Section B shall consist of 15 (Fifteen) questions in each subject (Question Nos – 36 to 50, 86 to 100, 136 to 150 and 186 to 200). In Section B, a candidate needs to attempt any 10 (Ten) questions out of 15 (Fifteen) in each subject.
- Candidates are advised to read all 15 questions in each subject of Section B before they start attempting the question paper. In the event of a candidate attempting more than ten questions, the first ten questions answered by the candidate shall be evaluated.
- Each question carries 4 marks. For each correct response, the candidate will get 4 marks. For each incorrect response, one mark will be deducted from the total scores. The maximum marks are 720.
 - Use Blue/Black Ball Point Pen only for writing particulars on this page/markings responses on Answer Sheet.
 - Rough work is to be done in the space provided for this purpose in the Test Booklet only.
 - On completion of the test, the candidate must hand over the Answer Sheet (ORIGINAL and OFFICE Copy) to the Invigilator before leaving the Room/Hall. The candidates are allowed to take away this Test Booklet with them.
 - The CODE for this Booklet is T3. Make sure that the CODE printed on the Original Copy of the Answer Sheet is the same as that on this Test Booklet. In case of discrepancy, the candidate should immediately report the matter to the Invigilator for replacement of both the Test Booklet and the Answer Sheet.
 - The candidates should ensure that the Answer Sheet is not folded. Do not make any stray marks on the Answer Sheet. Do not write your Roll No. anywhere else except in the specified space in the Test Booklet/ Answer Sheet.
 - Use of white fluid for correction is NOT permissible on the Answer Sheet.
 - Each candidate must show on-demand his/her Admit Card to the Invigilator.
 - No candidate, without special permission of the centre Superintendent or Invigilator, would leave his/her seat.
 - The candidates should not leave the Examination Hall without handing over their Answer Sheet to the Invigilator on duty and sign (with time) the Attendance Sheet twice. Cases, where a candidate has not signed the Attendance Sheet second time, will be deemed not to have handed over the Answer Sheet and dealt with as an Unfair Means case.
 - Use of Electronic/Manual Calculator is prohibited.
 - The candidates are governed by all Rules and Regulations of the examination with regard to their conduct in the Examination Room/Hall. All cases of unfair means will be dealt with as per the Rules and Regulations of this examination.
 - No part of the Test Booklet and Answer Sheet shall be detached under any circumstances.
 - The candidates will write the Correct Test Booklet Code as given in the Test Booklet/Answer Sheet in the Attendance Sheet.
 - Compensatory time of one hour five minutes will be provided for the examination of three hours and 20 minutes duration, whether such candidate (having a physical limitation to write) uses the facility of Scribe or not.

Name of the Candidate (in Capitals): P. MOOKTHA BHAVANI

Roll Number : In figures _____

: In words _____

Centre of Examination (in Capitals): _____

Candidate's Signature: _____

Invigilator's Signature: _____

Facsimile signature stamp of Centre Superintendent

Physics : Section-A (Q. No. 1 to 35)

1 A tightly wound 100 turns coil of radius 10 cm carries a current of 7 A. The magnitude of the magnetic field at the centre of the coil is (Take permeability of free space as $4\pi \times 10^{-7}$ SI units):

- (1) 4.4 mT (2) 44 T
 (3) 44 mT (4) 4.4 T

Match List-I with List-II.

List-I (Material)	List-II (Susceptibility (χ))
A. Diamagnetic	I. $\chi = 0$
B. Ferromagnetic	II. $0 > \chi \geq -1$
C. Paramagnetic	III. $\chi \gg 1$
D. Non-magnetic	IV. $0 < \chi < \epsilon$ (a small positive number)

Choose the correct answer from the options given below:

- (1) A-III, B-II, C-I, D-IV
 (2) A-IV, B-III, C-II, D-I
 (3) A-II, B-III, C-IV, D-I
 (4) A-II, B-I, C-III, D-IV

3 A thermodynamic system is taken through the cycle *abcd*. The work done by the gas along the path *bc* is :

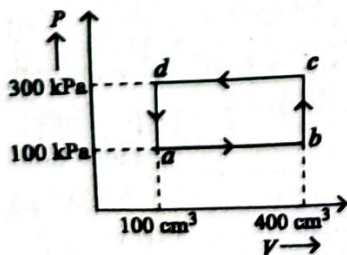

- (1) -90 J (2) -60 J
 (3) zero (4) 30 J

4 An unpolarised light beam strikes a glass surface at Brewster's angle. Then

- (1) both the reflected and refracted light will be completely polarised.
 (2) the reflected light will be completely polarised but the refracted light will be partially polarised.
 (3) the reflected light will be partially polarised.
 (4) the refracted light will be completely polarised.

5 In an ideal transformer, the turns ratio is $\frac{N_p}{N_s} = \frac{1}{2}$.

The ratio $V_s : V_p$ is equal to (the symbols carry their usual meaning) :

- (1) 1 : 1 (2) 1 : 4
 (3) 1 : 2 (4) 2 : 1

6 A logic circuit provides the output *Y* as per the following truth table :

A	B	Y
0	0	1
0	1	0
1	0	1
1	1	0

$A=0, B=0 \rightarrow \overline{A \cdot B} = Y$
 $A=0, B=1 \rightarrow \overline{A + B} = Y$
 $A=1, B=0 \rightarrow \overline{A \cdot B} = Y$
 $A=1, B=1 \rightarrow \overline{A \cdot B} = Y$

The expression for the output *Y* is :

- (1) \overline{B} 1010 (2) B 0101
 (3) $A \cdot B + \overline{A}$ 1010 (4) $A \cdot \overline{B} + \overline{A}$ 1010
 $0 \cdot 1 + 1 + 1 = 1$

7 In a vernier calipers, (*N* + 1) divisions of vernier scale coincide with *N* divisions of main scale. If 1 MSD represents 0.1 mm, the vernier constant (in cm) is :

- (1) 100*N* (2) 10 (*N* + 1)
 (3) $\frac{1}{10N}$ (4) $\frac{1}{100(N+1)}$

8 The maximum elongation of a steel wire of 1 m length if the elastic limit of steel and its Young's modulus, respectively, are $8 \times 10^8 \text{ N m}^{-2}$ and $2 \times 10^{11} \text{ N m}^{-2}$, is :

- (1) 40 mm (2) 8 mm
(3) 4 mm (4) 0.4 mm

9 A horizontal force 10 N is applied to a block A as shown in figure. The mass of blocks A and B are 2 kg and 3 kg, respectively. The blocks slide over a frictionless surface. The force exerted by block A on block B is :

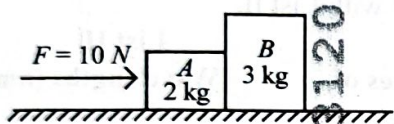

- (1) 6 N (2) 10 N
(3) zero (4) 4 N

10 If the monochromatic source in Young's double slit experiment is replaced by white light, then

- (1) there will be a central bright white fringe surrounded by a few coloured fringes.
(2) all bright fringes will be of equal width.
(3) interference pattern will disappear.
(4) there will be a central dark fringe surrounded by a few coloured fringes.

$$\lambda = \frac{h}{\sqrt{2mE}} \quad \lambda^2 \propto \frac{1}{E} \quad \lambda^2 = \frac{h}{2mE} \rightarrow E \propto \frac{1}{\lambda^2}$$

11 The graph which shows the variation of $\left(\frac{1}{\lambda^2}\right)$ and its kinetic energy, E is (where λ is de Broglie wavelength of a free particle) :

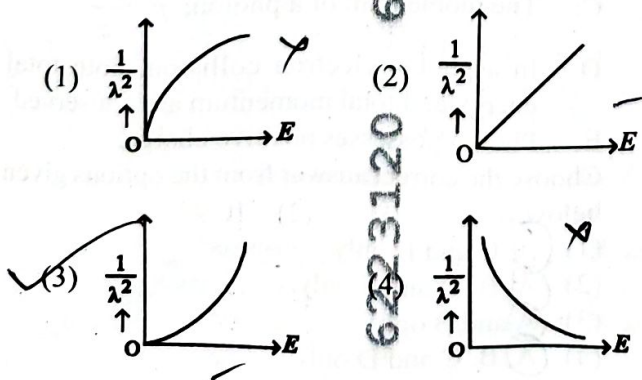

12 In the following circuit, the equivalent capacitance between terminal A and terminal B is :

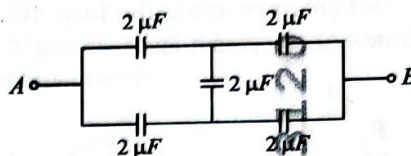

- (1) $0.5 \mu F$ (2) $4 \mu F$
(3) $2 \mu F$ (4) $1 \mu F$

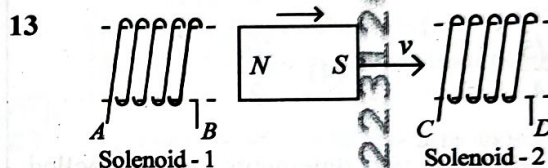

In the above diagram, a strong bar magnet is moving towards solenoid-2 from solenoid-1. The direction of induced current in solenoid-1 and that in solenoid-2, respectively, are through the directions:

- (1) AB and CD (2) BA and DC
(3) AB and DC (4) BA and CD

14 Consider the following statements A and B and identify the correct answer :

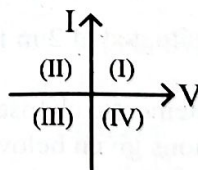

- A. For a solar-cell, the I-V characteristics lies in the IV quadrant of the given graph.
B. In a reverse biased pn junction diode, the current measured in (μA), is due to majority charge carriers.
(1) Both A and B are correct.
(2) Both A and B are incorrect.
(3) A is correct but B is incorrect.
(4) A is incorrect but B is correct.

- 15 A light ray enters through a right angled prism at point P with the angle of incidence 30° as shown in figure. It travels through the prism parallel to its base BC and emerges along the face AC . The refractive index of the prism is:

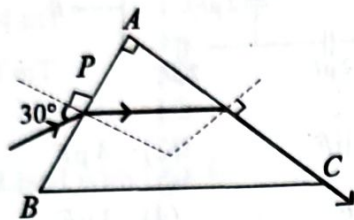

- (1) $\frac{\sqrt{3}}{4}$ (2) $\frac{\sqrt{3}}{2}$
 (3) $\frac{\sqrt{5}}{4}$ (4) $\frac{\sqrt{5}}{2}$

- 16 Given below are two statements: one is labelled as **Assertion A** and the other is labelled as **Reason R**.

Assertion A : The potential (V) at any axial point, at 2 m distance (r) from the centre of the dipole of dipole moment vector \vec{P} of magnitude, $4 \times 10^{-6} \text{ C m}$, is $\pm 9 \times 10^3 \text{ V}$.

(Take $\frac{1}{4\pi\epsilon_0} = 9 \times 10^9 \text{ SI units}$)

Reason R : $V = \pm \frac{2P}{4\pi\epsilon_0 r^2}$, where r is the

distance of any axial point, situated at 2 m from the centre of the dipole.

In the light of the above statements, choose the correct answer from the options given below:

- (1) A is true but R is false.
 (2) A is false but R is true.
 (3) Both A and R are true and R is the correct explanation of A.
 (4) Both A and R are true and R is NOT the correct explanation of A.

The moment of inertia of a thin rod about an axis passing through its mid point and perpendicular to the rod, is 2400 g cm^2 . The length of the 400 g rod is nearly:

- (1) 20.7 cm (2) 72.0 cm
 (3) 8.5 cm (4) 17.5 cm

- 18 The terminal voltage of the battery, whose emf is 10 V and internal resistance 1Ω , when connected through an external resistance of 4Ω as shown in the figure is:

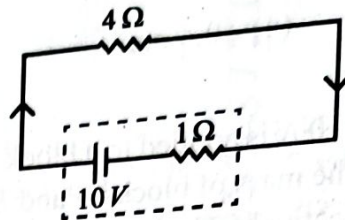

- (1) 8 V (2) 10 V
 (3) 4 V (4) 6 V

- 19 Match List I with List II.

List I
 (Spectral Lines of Hydrogen for transitions from)

List II
 (Wavelengths (nm))

- | | |
|---------------------------|------------|
| A. $n_2 = 3$ to $n_1 = 2$ | I. 410.2 |
| B. $n_2 = 4$ to $n_1 = 2$ | II. 434.1 |
| C. $n_2 = 5$ to $n_1 = 2$ | III. 656.3 |
| D. $n_2 = 6$ to $n_1 = 2$ | IV. 486.1 |

Choose the correct answer from the options given below:

- (1) A-IV, B-III, C-I, D-II
 (2) A-I, B-II, C-III, D-IV
 (3) A-II, B-I, C-IV, D-III
 (4) A-III, B-IV, C-II, D-I

- 20 If c is the velocity of light in free space, the correct statements about photon among the following are:

- A. The energy of a photon is $E = hv$. ✓
 B. The velocity of a photon is c .
 C. The momentum of a photon, $p = \frac{hv}{c}$.
 D. In a photon-electron collision, both total energy and total momentum are conserved.
 E. Photon possesses positive charge.

Choose the correct answer from the options given below:

- (1) A, C and D only
 (2) A, B, D and E only
 (3) A and B only
 (4) A, B, C and D only

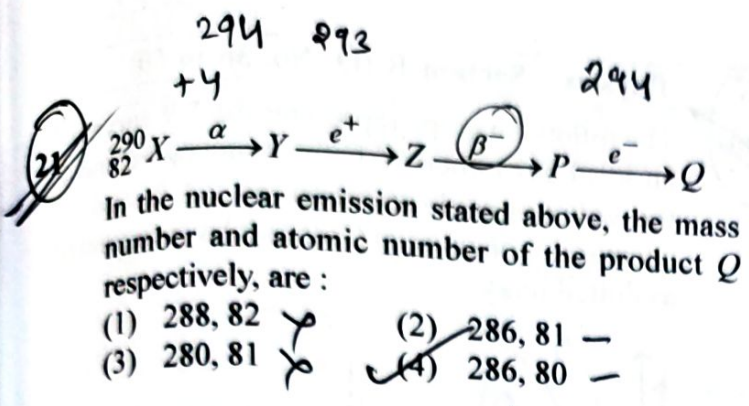

22 At any instant of time t , the displacement of any particle is given by $2t - 1$ (SI unit) under the influence of force of $5N$. The value of instantaneous power is (in SI unit):

(1) 7 (2) 6
 (3) 10 (4) 5 $f = 5N$

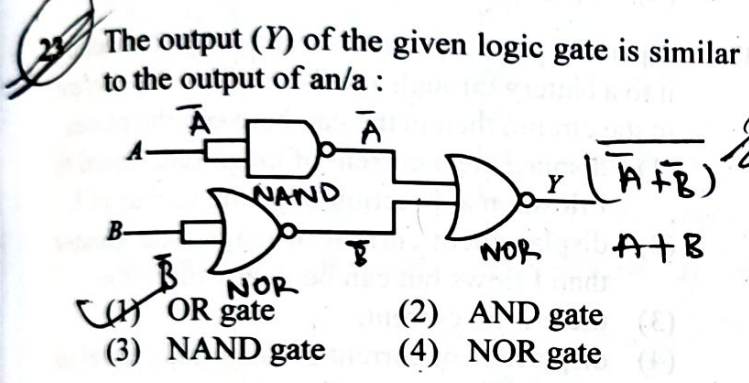

24 The mass of a planet is $\frac{1}{10}$ th that of the earth and its diameter is half that of the earth. The acceleration due to gravity on that planet is :

(1) 4.9 m s^{-2} (2) 3.92 m s^{-2}
 (3) 19.6 m s^{-2} (4) 9.8 m s^{-2}

25 Given below are two statements :

Statement I : Atoms are electrically neutral as they contain equal number of positive and negative charges.

Statement II : Atoms of each element are stable and emit their characteristic spectrum.

In the light of the above statements, choose the most appropriate answer from the options given below :

(1) Statement I is correct but Statement II is incorrect.
 (2) Statement I is incorrect but Statement II is correct.
 (3) Both Statement I and Statement II are correct.
 (4) Both Statement I and Statement II are incorrect.

26 A wheel of a bullock cart is rolling on a level road as shown in the figure below. If its linear speed is v in the direction shown, which one of the following options is correct (P and Q are any highest and lowest points on the wheel, respectively)?

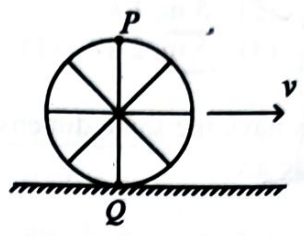

- (1) Both the points P and Q move with equal speed.
 (2) Point P has zero speed.
 (3) Point P moves slower than point Q.
 (4) Point P moves faster than point Q.

27 A particle moving with uniform speed in a circular path maintains :

(1) constant velocity but varying acceleration.
 (2) varying velocity and varying acceleration.
 (3) constant velocity.
 (4) constant acceleration.

28 A thin flat circular disc of radius 4.5 cm is placed gently over the surface of water. If surface tension of water is 0.07 Nm^{-1} , then the excess force required to take it away from the surface is :

(1) 1.98 mN (2) 99 N
 (3) 19.8 mN (4) 198 N

29 In a uniform magnetic field of 0.049 T , a magnetic needle performs 20 complete oscillations in 5 seconds as shown. The moment of inertia of the needle is $9.8 \times 10^{-6} \text{ kg m}^2$. If the magnitude of magnetic moment of the needle is $x \times 10^{-5} \text{ Am}^2$; then the value of 'x' is :

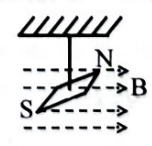

(1) $50 \pi^2$ (2) $1280 \pi^2$
 (3) $5 \pi^2$ (4) $128 \pi^2$

Handwritten calculations: 0.049 , 20 , 5 , 9.8×10^{-6} , 10^{-5} , 1769 , $1769 \times 2 = 3538$, $3538 \times 2 = 7076$, $7076 \times 2 = 14152$, $14152 \times 2 = 28304$, $28304 \times 2 = 56608$, $56608 \times 2 = 113216$, $113216 \times 2 = 226432$, $226432 \times 2 = 452864$, $452864 \times 2 = 905728$, $905728 \times 2 = 1811456$, $1811456 \times 2 = 3622912$, $3622912 \times 2 = 7245824$, $7245824 \times 2 = 14491648$, $14491648 \times 2 = 28983296$, $28983296 \times 2 = 57966592$, $57966592 \times 2 = 115933184$, $115933184 \times 2 = 231866368$, $231866368 \times 2 = 463732736$, $463732736 \times 2 = 927465472$, $927465472 \times 2 = 1854930944$, $1854930944 \times 2 = 3709861888$, $3709861888 \times 2 = 7419723776$, $7419723776 \times 2 = 14839447552$, $14839447552 \times 2 = 29678895104$, $29678895104 \times 2 = 59357790208$, $59357790208 \times 2 = 118715580416$, $118715580416 \times 2 = 237431160832$, $237431160832 \times 2 = 474862321664$, $474862321664 \times 2 = 949724643328$, $949724643328 \times 2 = 1899449286656$, $1899449286656 \times 2 = 3798898573312$, $3798898573312 \times 2 = 7597797146624$, $7597797146624 \times 2 = 15195594293248$, $15195594293248 \times 2 = 30391188586496$, $30391188586496 \times 2 = 60782377172992$, $60782377172992 \times 2 = 121564754345984$, $121564754345984 \times 2 = 243129508691968$, $243129508691968 \times 2 = 486259017383936$, $486259017383936 \times 2 = 972518034767872$, $972518034767872 \times 2 = 1945036069535744$, $1945036069535744 \times 2 = 3890072139071488$, $3890072139071488 \times 2 = 7780144278142976$, $7780144278142976 \times 2 = 15560288556285952$, $15560288556285952 \times 2 = 31120577112571904$, $31120577112571904 \times 2 = 62241154225143808$, $62241154225143808 \times 2 = 124482308450287616$, $124482308450287616 \times 2 = 248964616900575232$, $248964616900575232 \times 2 = 497929233801150464$, $497929233801150464 \times 2 = 995858467602300928$, $995858467602300928 \times 2 = 1991716935204601856$, $1991716935204601856 \times 2 = 3983433870409203712$, $3983433870409203712 \times 2 = 7966867740818407424$, $7966867740818407424 \times 2 = 15933735481636814848$, $15933735481636814848 \times 2 = 31867470963273629696$, $31867470963273629696 \times 2 = 63734941926547259392$, $63734941926547259392 \times 2 = 127469883853094518784$, $127469883853094518784 \times 2 = 254939767706189037568$, $254939767706189037568 \times 2 = 509879535412378075136$, $509879535412378075136 \times 2 = 1019759070824756150272$, $1019759070824756150272 \times 2 = 2039518141649512300544$, $2039518141649512300544 \times 2 = 4079036283299024601088$, $4079036283299024601088 \times 2 = 8158072566598049202176$, $8158072566598049202176 \times 2 = 16316145133196098404352$, $16316145133196098404352 \times 2 = 32632290266392196808704$, $32632290266392196808704 \times 2 = 65264580532784393617408$, $65264580532784393617408 \times 2 = 130529161065568787234816$, $130529161065568787234816 \times 2 = 261058322131137574469632$, $261058322131137574469632 \times 2 = 522116644262275148939264$, $522116644262275148939264 \times 2 = 1044233288524550297878528$, $1044233288524550297878528 \times 2 = 2088466577049100595757056$, $2088466577049100595757056 \times 2 = 4176933154098201191514112$, $4176933154098201191514112 \times 2 = 8353866308196402383028224$, $8353866308196402383028224 \times 2 = 16707732616392804766056448$, $16707732616392804766056448 \times 2 = 33415465232785609532112896$, $33415465232785609532112896 \times 2 = 66830930465571219064225792$, $66830930465571219064225792 \times 2 = 133661860931142438128451584$, $133661860931142438128451584 \times 2 = 267323721862284876256903168$, $267323721862284876256903168 \times 2 = 534647443724569752513806336$, $534647443724569752513806336 \times 2 = 1069294887449139505027612672$, $1069294887449139505027612672 \times 2 = 2138589774898279010055225344$, $2138589774898279010055225344 \times 2 = 4277179549796558020110450688$, $4277179549796558020110450688 \times 2 = 8554359099593116040220901376$, $8554359099593116040220901376 \times 2 = 17108718199186232080441802752$, $17108718199186232080441802752 \times 2 = 34217436398372464160883605504$, $34217436398372464160883605504 \times 2 = 68434872796744928321767211008$, $68434872796744928321767211008 \times 2 = 136869745593489856643534422016$, $136869745593489856643534422016 \times 2 = 273739491186979713287068844032$, $273739491186979713287068844032 \times 2 = 547478982373959426574137688064$, $547478982373959426574137688064 \times 2 = 1094957964747918853148275376128$, $1094957964747918853148275376128 \times 2 = 2189915929495837706296550752256$, $2189915929495837706296550752256 \times 2 = 4379831858991675412593101504512$, $4379831858991675412593101504512 \times 2 = 8759663717983350825186203009024$, $8759663717983350825186203009024 \times 2 = 17519327435966701650372406018048$, $17519327435966701650372406018048 \times 2 = 35038654871933403300744812036096$, $35038654871933403300744812036096 \times 2 = 70077309743866806601489624072192$, $70077309743866806601489624072192 \times 2 = 140154619487733613202979248144384$, $140154619487733613202979248144384 \times 2 = 280309238975467226405958496288768$, $280309238975467226405958496288768 \times 2 = 560618477950934452811916992577536$, $560618477950934452811916992577536 \times 2 = 1121236955901868905623833985155072$, $1121236955901868905623833985155072 \times 2 = 2242473911803737811247667970310144$, $2242473911803737811247667970310144 \times 2 = 4484947823607475622495335940620288$, $4484947823607475622495335940620288 \times 2 = 8969895647214951244990671881240576$, $8969895647214951244990671881240576 \times 2 = 17939791294429902489981343762481152$, $17939791294429902489981343762481152 \times 2 = 35879582588859804979962687524962304$, $35879582588859804979962687524962304 \times 2 = 71759165177719609959925375049924608$, $71759165177719609959925375049924608 \times 2 = 143518330355439219919850750099849216$, $143518330355439219919850750099849216 \times 2 = 287036660710878439839701500199698432$, $287036660710878439839701500199698432 \times 2 = 574073321421756879679403000399396864$, $574073321421756879679403000399396864 \times 2 = 1148146642843513759358806000798793728$, $1148146642843513759358806000798793728 \times 2 = 2296293285687027518717612001597587456$, $2296293285687027518717612001597587456 \times 2 = 4592586571374055037435224003195174912$, $4592586571374055037435224003195174912 \times 2 = 9185173142748110074870448006390349824$, $9185173142748110074870448006390349824 \times 2 = 18370346285496220149740896012780699648$, $18370346285496220149740896012780699648 \times 2 = 36740692570992440299481792025561399296$, $36740692570992440299481792025561399296 \times 2 = 73481385141984880598963584051122798592$, $73481385141984880598963584051122798592 \times 2 = 146962770283969761197927168102245597184$, $146962770283969761197927168102245597184 \times 2 = 293925540567939522395854336204491194368$, $293925540567939522395854336204491194368 \times 2 = 587851081135879044791708672408982388736$, $587851081135879044791708672408982388736 \times 2 = 1175702162271758089583417344817964777472$, $1175702162271758089583417344817964777472 \times 2 = 2351404324543516179166834689635929554944$, $2351404324543516179166834689635929554944 \times 2 = 4702808649087032358333669379271859109888$, $4702808649087032358333669379271859109888 \times 2 = 9405617298174064716667338758543718219776$, $9405617298174064716667338758543718219776 \times 2 = 18811234596348129433334677517087436439552$, $18811234596348129433334677517087436439552 \times 2 = 37622469192696258866669355034174872879104$, $37622469192696258866669355034174872879104 \times 2 = 75244938385392517733338710068349745758208$, $75244938385392517733338710068349745758208 \times 2 = 150489876770785035466677420136699491516416$, $150489876770785035466677420136699491516416 \times 2 = 300979753541570070933354840273398983032832$, $300979753541570070933354840273398983032832 \times 2 = 601959507083140141866709680546797966065664$, $601959507083140141866709680546797966065664 \times 2 = 1203919014166280283733419361093595932131328$, $1203919014166280283733419361093595932131328 \times 2 = 2407838028332560567466838722187191864262656$, $2407838028332560567466838722187191864262656 \times 2 = 4815676056665121134933677444374383728525312$, $4815676056665121134933677444374383728525312 \times 2 = 9631352113330242269867354888748767457050624$, $9631352113330242269867354888748767457050624 \times 2 = 19262704226660484539734709777497534914101248$, $19262704226660484539734709777497534914101248 \times 2 = 38525408453320969079469419554995069828202496$, $38525408453320969079469419554995069828202496 \times 2 = 77050816906641938158938839109990139656404992$, $77050816906641938158938839109990139656404992 \times 2 = 154101633813283876317877678219980279312809984$, $154101633813283876317877678219980279312809984 \times 2 = 308203267626567752635755356439960558625619968$, $308203267626567752635755356439960558625619968 \times 2 = 616406535253135505271510712879921117251239936$, $616406535253135505271510712879921117251239936 \times 2 = 1232813070506271010543021425759842234502479872$, $1232813070506271010543021425759842234502479872 \times 2 = 2465626141012542021086042851519684469004959744$, $2465626141012542021086042851519684469004959744 \times 2 = 4931252282025084042172085703039368938009919488$, $4931252282025084042172085703039368938009919488 \times 2 = 9862504564050168084344171406078737876019838976$, $9862504564050168084344171406078737876019838976 \times 2 = 19725009128100336168688342812157475752039677952$, $19725009128100336168688342812157475752039677952 \times 2 = 39450018256200672337376685624314951504079355904$, $39450018256200672337376685624314951504079355904 \times 2 = 78900036512401344674753371248629903008158711808$, $78900036512401344674753371248629903008158711808 \times 2 = 157800073024802689349506742497259806016317423616$, $157800073024802689349506742497259806016317423616 \times 2 = 315600146049605378699013484994519612032634847232$, $315600146049605378699013484994519612032634847232 \times 2 = 631200292099210757398026969989039224065269694464$, $631200292099210757398026969989039224065269694464 \times 2 = 1262400584198421514796053939978078448130539388928$, $1262400584198421514796053939978078448130539388928 \times 2 = 2524801168396843029592107879956156896261078777856$, $2524801168396843029592107879956156896261078777856 \times 2 = 5049602336793686059184215759912313792522157555712$, $5049602336793686059184215759912313792522157555712 \times 2 = 10099204673587372118368431519824627585044315111424$, $10099204673587372118368431519824627585044315111424 \times 2 = 20198409347174744236736863039649255170088630222848$, $20198409347174744236736863039649255170088630222848 \times 2 = 40396818694349488473473726079298510340177260445696$, $40396818694349488473473726079298510340177260445696 \times 2 = 80793637388698976946947452158597020680354520891392$, $80793637388698976946947452158597020680354520891392 \times 2 = 161587274777397953893894904317194041360709041782784$, $161587274777397953893894904317194041360709041782784 \times 2 = 32317454955479590$

31 If $x = 5 \sin \left(\pi t + \frac{\pi}{3} \right) m$ represents the motion of a particle executing simple harmonic motion, the amplitude and time period of motion, respectively, are :

- (1) 5 cm, 1 s
- (2) 5 m, 1 s
- (3) 5 cm, 2 s
- (4) 5 m, 2 s

32 The quantities which have the same dimensions as those of solid angle are :

- (1) strain and arc
- (2) angular speed and stress
- (3) strain and angle
- (4) stress and angle

33 A thin spherical shell is charged by some source. The potential difference between the two points C and P (in V) shown in the figure is:

(Take $\frac{1}{4\pi\epsilon_0} = 9 \times 10^9$ SI units)

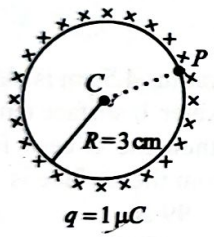

- (1) 0.5×10^5
- (2) zero
- (3) 3×10^5
- (4) 1×10^5

34 A bob is whirled in a horizontal plane by means of a string with an initial speed of ω rpm. The tension in the string is T . If speed becomes 2ω while keeping the same radius, the tension in the string becomes :

- (1) $\frac{T}{4}$
- (2) $\sqrt{2}T$
- (3) T
- (4) $4T$

35 A wire of length 'l' and resistance 100Ω is divided into 10 equal parts. The first 5 parts are connected in series while the next 5 parts are connected in parallel. The two combinations are again connected in series. The resistance of this final combination is:

- (1) 55Ω
- (2) 60Ω
- (3) 26Ω
- (4) 52Ω

The following graph represents the T-V curves of an ideal gas (where T is the temperature and V the volume) at three pressures P_1, P_2 and P_3 compared with those of Charles's law represented as dotted lines

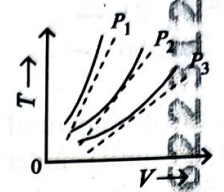

Then the correct relation is:

- (1) $P_2 > P_1 > P_3$
- (2) $P_1 > P_2 > P_3$
- (3) $P_3 > P_2 > P_1$
- (4) $P_1 > P_3 > P_2$

37 A parallel plate capacitor is charged by connecting it to a battery through a resistor. If I is the current in the circuit, then in the gap between the plates :

- (1) displacement current of magnitude equal to I flows in a direction opposite to that of I.
- (2) displacement current of magnitude greater than I flows but can be in any direction.
- (3) there is no current.
- (4) displacement current of magnitude equal to I flows in the same direction as I.

The property which is not of an electromagnetic wave travelling in free space is that :

- (1) they travel with a speed equal to $\frac{1}{\sqrt{\mu_0 \epsilon_0}}$
- (2) they originate from charges moving with uniform speed.
- (3) they are transverse in nature.
- (4) the energy density in electric field is equal to energy density in magnetic field.

38 Choose the correct circuit which can achieve the bridge balance.

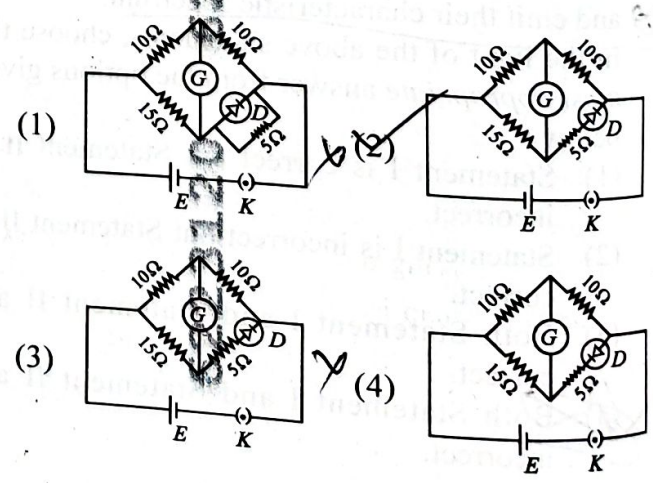

- 40 If the plates of a parallel plate capacitor connected to a battery are moved close to each other, then
- the charge stored in it, increases.
 - the energy stored in it, decreases.
 - its capacitance increases.
 - the ratio of charge to its potential remains the same.
 - the product of charge and voltage increases.

Choose the most appropriate answer from the options given below:

- (1) B, D and E only (2) A, B and C only
 (3) A, B and E only (4) A, C and E only

- 41 A force defined by $F = \alpha t^2 + \beta t$ acts on a particle at a given time t . The factor which is dimensionless, if α and β are constants, is:

- (1) $\alpha\beta t$ (2) $\frac{\alpha\beta}{t}$
 (3) $\frac{\beta t}{\alpha}$ (4) $\frac{\alpha t}{\beta}$

A metallic bar of Young's modulus, $0.5 \times 10^{11} \text{ N m}^{-2}$ and coefficient of linear thermal expansion $10^{-5} \text{ }^\circ\text{C}^{-1}$ length 1 m and area of cross-section 10^{-3} m^2 is heated from 0°C to 100°C without expansion or bending. The compressive force developed in it is:

- (1) $100 \times 10^3 \text{ N}$ ✗ (2) $2 \times 10^3 \text{ N}$ ✗
 (3) $5 \times 10^3 \text{ N}$ ✓ (4) $50 \times 10^3 \text{ N}$ ✓

A small telescope has an objective of focal length 140 cm and an eye piece of focal length 5.0 cm. The magnifying power of telescope for viewing a distant object is:

- (1) 17 ✗ (2) 32 - $\frac{140}{5} = 28$
 (3) 34 ✗ (4) 28 - $\frac{140}{5} = 28$

- 44 An iron bar of length L has magnetic moment M . It is bent at the middle of its length such that the two arms make an angle 60° with each other. The magnetic moment of this new magnet is:

- (1) $2M$ (2) $\frac{M}{\sqrt{3}}$
 (3) M (4) $\frac{M}{2}$

- 45 A $10 \mu\text{F}$ capacitor is connected to a 210 V, 50 Hz source as shown in figure. The peak current in the circuit is nearly ($\pi = 3.14$):

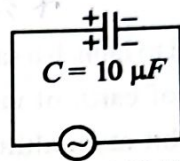

210 V, 50 Hz

- (1) 1.20 A (2) 0.35 A
 (3) 0.58 A (4) 0.93 A

- 46 Two heaters A and B have power rating of 1 kW and 2 kW, respectively. Those two are first connected in series and then in parallel to a fixed power source. The ratio of power outputs for these two cases is:

- (1) 1 : 2 (2) 2 : 3
 (3) 1 : 1 (4) 2 : 9

- 47 The velocity (v) - time (t) plot of the motion of a body is shown below:

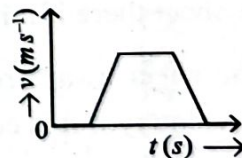

The acceleration (a) - time (t) graph that best suits this motion is:

- (1) (2)
 (3) (4)

48

If the mass of the bob in a simple pendulum is increased to thrice its original mass and its length is made half its original length, then the new time

period of oscillation is $\frac{x}{2}$ times its original time period. Then the value of x is:

- (1) $2\sqrt{3}$ (2) 4
 (3) $\sqrt{3}$ (4) $\sqrt{2}$

49 The minimum energy required to launch a satellite of mass m from the surface of earth of mass M and radius R in a circular orbit at an altitude of $2R$ from the surface of the earth is:

- (1) $\frac{GmM}{2R}$ (2) $\frac{GmM}{3R}$
 (3) $\frac{5GmM}{6R}$ (4) $\frac{2GmM}{3R}$

50 A sheet is placed on a horizontal surface in front of a strong magnetic pole. A force is needed to :

- A. hold the sheet there if it is magnetic.
 B. hold the sheet there if it is non-magnetic.
 C. move the sheet away from the pole with uniform velocity if it is conducting.
 D. move the sheet away from the pole with uniform velocity if it is both, non-conducting and non-polar.

Choose the correct statement(s) from the options given below:

- (1) A, C and D only
 (2) C only
 (3) B and D only
 (4) A and C only

51 Match List I with List II.

List I
(Conversion)

List II
(Number of Faraday required)

- A. 1 mol of H_2O to O_2 I. 3F
 B. 1 mol of MnO_4^- to Mn^{2+} II. 2F
 C. 1.5 mol of Ga from molten $CaCl_2$ III. 1F
 D. 1 mol of FeO to Fe_2O_3 IV. 5F



Choose the correct answer from the options given below:

- (1) A-II, B-III, C-I, D-IV
 (2) A-III, B-IV, C-II, D-I
 (3) A-II, B-IV, C-I, D-III
 (4) A-III, B-IV, C-I, D-II

52 Which reaction is NOT a redox reaction?

- (1) $H_2 + Cl_2 \rightarrow 2 HCl$
 (2) $BaCl_2 + Na_2SO_4 \rightarrow BaSO_4 + 2 NaCl$
 (3) $Zn + CuSO_4 \rightarrow ZnSO_4 + Cu$
 (4) $2 KClO_3 + I_2 \rightarrow 2 KIO_3 + Cl_2$

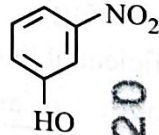
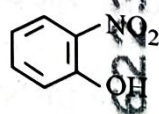
53 Intramolecular hydrogen bonding is present in

- (1) 
 (2) HF
 (3) 
 (4) 

54 Fehling's solution 'A' is

- (1) alkaline solution of sodium potassium tartrate (Rochelle's salt)
 (2) aqueous sodium citrate
 (3) aqueous copper sulphate
 (4) alkaline copper sulphate

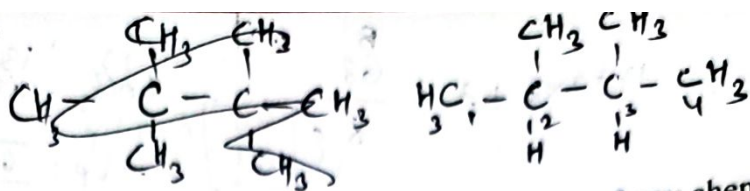

55 1 gram of sodium hydroxide was treated with 25 mL of 0.75 M HCl solution, the mass of sodium hydroxide left unreacted is equal to

(1) Zero mg (2) 200 mg
(3) 750 mg (4) 250 mg

59

Activation energy of any chemical reaction can be calculated if one knows the value of

(1) orientation of reactant molecules during collision. ✓
(2) rate constant at two different temperatures.
(3) rate constant at standard temperature.
(4) probability of collision. ✓

Match List I with List II.

List I (Compound)	List II (Shape/geometry)
A. NH ₃	I. Trigonal Pyramidal
B. BrF ₅	II. Square Planar
C. XeF ₄	III. Octahedral
D. SF ₆	IV. Square Pyramidal

Choose the correct answer from the options given below:

- (1) A-III, B-IV, C-I, D-II
(2) A-II, B-III, C-IV, D-I
(3) A-I, B-IV, C-II, D-III
(4) A-II, B-IV, C-III, D-I ✓

57 The E° value for the Mn³⁺/Mn²⁺ couple is more positive than that of Cr³⁺/Cr²⁺ or Fe³⁺/Fe²⁺ due to change of

- (1) d⁴ to d⁵ configuration
(2) d³ to d⁵ configuration
(3) d⁵ to d⁴ configuration
(4) d⁵ to d² configuration

Match List I with List II.

List I (Process)	List II (Conditions)
A. Isothermal process	I. No heat exchange
B. Isochoric process	II. Carried out at constant temperature
C. Isobaric process	III. Carried out at constant volume
D. Adiabatic process	IV. Carried out at constant pressure

Choose the correct answer from the options given below:

- (1) A-I, B-II, C-III, D-IV
(2) A-II, B-III, C-IV, D-I ✓
(3) A-IV, B-III, C-II, D-I
(4) A-IV, B-II, C-III, D-I

A compound with a molecular formula of C₆H₁₄ has two tertiary carbons. Its IUPAC name is:

- (1) 2,3-dimethylbutane ✓
(2) 2,2-dimethylbutane
(3) n-hexane
(4) 2-methylpentane

'Spin only' magnetic moment is same for which of the following ions?

- A. Ti³⁺ B. Cr²⁺
C. Mn²⁺ D. Fe²⁺
E. Sc³⁺

Choose the most appropriate answer from the options given below:

- (1) B and C only
(2) A and D only
(3) B and D only
(4) A and E only

Arrange the following elements in increasing order of electronegativity:

N, O, F, C, Si

Choose the correct answer from the options given below:

- (1) O < F < N < C < Si ✓
(2) F < O < N < C < Si ✓
(3) Si < C < N < O < F
(4) Si < C < O < N < F

Which one of the following alcohols reacts instantaneously with Lucas reagent? 3° alc.

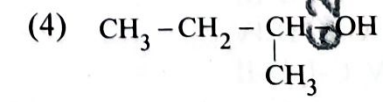
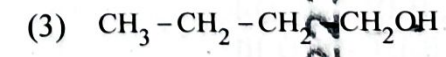
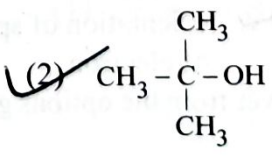
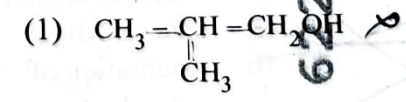

The reagents with which glucose does **not** react to give the corresponding tests/products are

- A. Tollen's reagent
- B. Schiff's reagent ✓
- C. HCN
- D. NH_2OH
- E. NaHSO_3 ✓

Choose the correct options from the given below:

- (1) B and E
- (2) E and D
- (3) B and C ✓
- (4) A and D

Match List I with List II.

List I

(Molecule)

List II

(Number and types of bonds between two carbon atoms)



- | | |
|----------------------------------|--|
| A. ethane | I. one σ -bond and two π -bonds |
| B. ethene | II. two π -bonds |
| C. carbon molecule, C_2 | III. one σ -bond |
| D. ethyne | IV. one σ -bond and one π -bond |

Choose the correct answer from the options given below:

- (1) A-III, B-IV, C-II, D-I ✓
- (2) A-III, B-IV, C-I, D-II
- (3) A-I, B-IV, C-II, D-III
- (4) A-IV, B-III, C-II, D-I

Among Group 16 elements, which one does **NOT** show -2 oxidation state?

- (1) Te ✓
- (2) Po ✓
- (3) O ✓
- (4) Se ✓

For the reaction $2\text{A} \rightleftharpoons \text{B} + \text{C}$, $K_c = 4 \times 10^{-3}$. At a given time, the composition of reaction mixture is: $[\text{A}] = [\text{B}] = [\text{C}] = 2 \times 10^{-3} \text{ M}$.

Then, which of the following is correct?

- (1) Reaction has a tendency to go in backward direction.
- (2) Reaction has gone to completion in forward direction.
- (3) Reaction is at equilibrium. ✓
- (4) Reaction has a tendency to go in forward direction.

Which plot of $\ln k$ vs $\frac{1}{T}$ is consistent with Arrhenius equation?

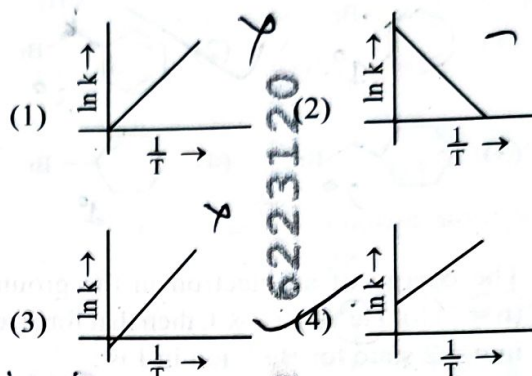

In which of the following equilibria, K_p and K_c are **NOT** equal?

- (1) $\text{CO}_{(g)} + \text{H}_2\text{O}_{(g)} \rightleftharpoons \text{CO}_2_{(g)} + \text{H}_2_{(g)}$
- (2) $2 \text{BrCl}_{(g)} \rightleftharpoons \text{Br}_2_{(g)} + \text{Cl}_2_{(g)}$
- (3) $\text{PCl}_5_{(g)} \rightleftharpoons \text{PCl}_3_{(g)} + \text{Cl}_2_{(g)}$
- (4) $\text{H}_2_{(g)} + \text{I}_2_{(g)} \rightleftharpoons 2 \text{HI}_{(g)}$

Given below are two statements:

Statement I : The boiling point of three isomeric pentanes follows the order

n-pentane > isopentane > neopentane

Statement II : When branching increases, the molecule attains a shape of sphere. This results in smaller surface area for contact, due to which the intermolecular forces between the spherical molecules are weak, thereby lowering the boiling point.

In the light of the above statements, choose the **most appropriate** answer from the options given below:

- (1) Statement I is correct but Statement II is incorrect.
- (2) Statement I is incorrect but Statement II is correct.
- (3) Both Statement I and Statement II are correct. ✓
- (4) Both Statement I and Statement II are incorrect.

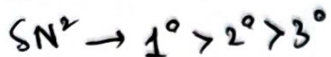
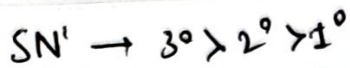

76

The compound that will undergo SN^1 reaction with the fastest rate is

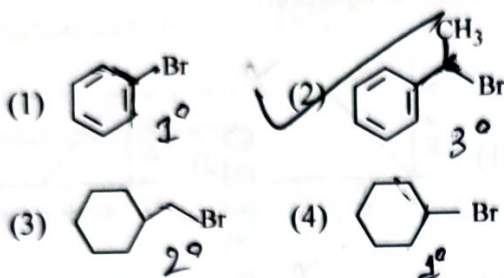

77 The energy of an electron in the ground state ($n = 1$) for He^+ ion is $-x$ J, then that for an electron in $n = 2$ state for Be^{3+} ion in J is :

- (1) $-4x$ (2) $-\frac{4}{9}x$ $E \propto \frac{1}{n^2}$
- (3) $-x$ (4) $-\frac{x}{9}$ $-xJ \rightarrow 1$
 $? \rightarrow 2$

78 In which of the following processes entropy increases? $\Delta S \uparrow$ spontaneous.

- A. A liquid evaporates to vapour. $\Delta G < 0$ -ve
 $\Delta H < 0$ -ve
- B. Temperature of a crystalline solid lowered from 130 K to 0 K.
- C. $2 NaHCO_3(s) \rightarrow Na_2CO_3(s) + CO_2(g) + H_2O(g)$
- D. $Cl_2(g) \rightarrow 2 Cl(g)$

Choose the correct answer from the options given below:

- (1) A, C and D (2) C and D
(3) A and C (4) A, B and D

79

On heating, some solid substances change from solid to vapour state without passing through liquid state. The technique used for the purification of such solid substances based on the above principle is known as

- (1) Distillation (2) Chromatography
(3) Crystallization (4) Sublimation

solid \rightarrow vapour

T3_English]

80

Match List I with List II.

List I (Complex)

List II (Type of isomerism)

- A. $[Co(NH_3)_5(NO_2)]Cl_2$ I. Solvate isomerism
- B. $[Co(NH_3)_5(SO_4)]Br$ II. Linkage isomerism
- C. $[Co(NH_3)_6][Cr(CN)_6]$ III. Ionization isomerism
- D. $[Co(H_2O)_6]Cl_3$ IV. Coordination isomerism

Choose the correct answer from the options given below:

- (1) A-I, B-IV, C-III, D-II
(2) A-II, B-IV, C-III, D-I
(3) A-II, B-III, C-IV, D-I
(4) A-I, B-III, C-IV, D-II

81

Given below are two statements:

Statement I : Aniline does not undergo Friedel-Crafts alkylation reaction.

Statement II : Aniline cannot be prepared through Gabriel synthesis.

In the light of the above statements, choose the correct answer from the options given below:

- (1) Statement I is correct but Statement II is false.
(2) Statement I is incorrect but Statement II is true.
(3) Both Statement I and Statement II are true.
(4) Both Statement I and Statement II are false.

82 Arrange the following elements in increasing order of first ionization enthalpy:

Li, Be, B, C, N

Choose the correct answer from the options given below:

- (1) $Li < Be < C < B < N$
- (2) $Li < Be < N < B < C$
- (3) $Li < Be < B < C < N$
- (4) $Li < B < Be < C < N$

83 The highest number of helium atoms is in

- (1) 4 g of helium $\frac{4}{4} = 1$
- (2) 2.271098 L of helium at STP $\frac{2.271 \times 10}{22.4} \times \frac{1.35}{10} = 0.1$
- (3) 4 mol of helium 4
- (4) 4 u of helium $\frac{113.5}{112} = 1.013$

84 The most stable carbocation among the following is:

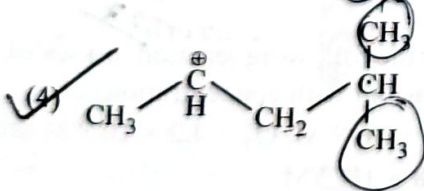
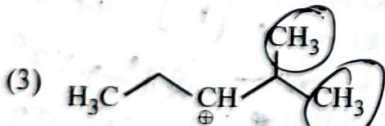
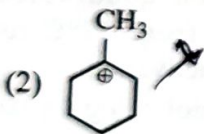
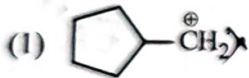

85 The Henry's law constant (K_H) values of three gases (A, B, C) in water are 145, 2×10^{-5} and 35 kbar, respectively. The solubility of these gases in water follow the order:

- (1) $A > C > B$
- (2) $A > B > C$
- (3) $B > A > C$
- (4) $B > C > A$

86

A compound X contains 32% of A, 20% of B and remaining percentage of C. Then, the empirical formula of X is:

(Given atomic masses of A = 64; B = 40; C = 32 u)

- (1) AB_2C_2
- (2) ABC_4
- (3) A_2BC_2
- (4) ABC_3

The products A and B obtained in the following reactions, respectively, are



- (1) H_3PO_4 and $POCl_3$
- (2) H_3PO_3 and $POCl_3$
- (3) $POCl_3$ and H_3PO_3
- (4) $POCl_3$ and H_3PO_4

88

The plot of osmotic pressure (Π) vs concentration (mol L^{-1}) for a solution gives a straight line with slope $25.73 \text{ L bar mol}^{-1}$. The temperature at which the osmotic pressure measurement is done is:

(Use $R = 0.083 \text{ L bar mol}^{-1} \text{ K}^{-1}$)

- (1) 25.73°C
- (2) 12.05°C
- (3) 37°C
- (4) 310°C

For the given reaction:

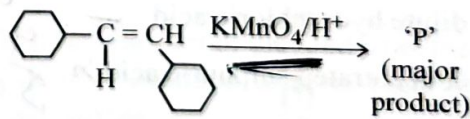

'P' is

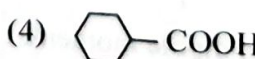
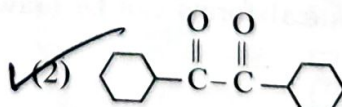
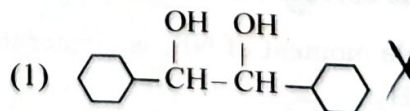

90 Given below are two statements :

Statement I : $[\text{Co}(\text{NH}_3)_6]^{3+}$ is a homoleptic complex whereas $[\text{Co}(\text{NH}_3)_4(\text{Cl}_2)]^+$ is a heteroleptic complex.
 not a ligand

Statement II : Complex $[\text{Co}(\text{NH}_3)_6]^{3+}$ has only one kind of ligands but $[\text{Co}(\text{NH}_3)_4(\text{Cl}_2)]^+$ has more than one kind of ligands.

In the light of the above statements, choose the correct answer from the options given below:

- (1) Statement I is true but Statement II is false.
- (2) Statement I is false but Statement II is true.
- (3) Both Statement I and Statement II are true.
- (4) Both Statement I and Statement II are false.

91 During the preparation of Mohr's salt solution (Ferrous ammonium sulphate), which of the following acid is added to prevent hydrolysis of Fe^{2+} ion?

- (1) dilute nitric acid
- (2) dilute sulphuric acid
- (3) dilute hydrochloric acid
- (4) concentrated sulphuric acid

30
x 32
60
900
3960
x 6
596

92 Identify the correct answer.

- (1) Dipole moment of NF_3 is greater than that of NH_3 .
- (2) Three canonical forms can be drawn for CO_3^{2-} ion.
- (3) Three resonance structures can be drawn for ozone.
- (4) BF_3 has non-zero dipole moment.

93

Given below are certain cations. Using inorganic qualitative analysis, arrange them in increasing group number from 0 to VI.

- A. Al^{3+}
- B. Cu^{2+}
- C. Ba^{2+}
- D. Co^{2+}
- E. Mg^{2+}

Choose the correct answer from the options given below:

- (1) E, C, D, B, A
- (2) E, A, B, C, D
- (3) B, A, D, C, E
- (4) B, C, A, D, E

94

Identify the major product C formed in the following reaction sequence :

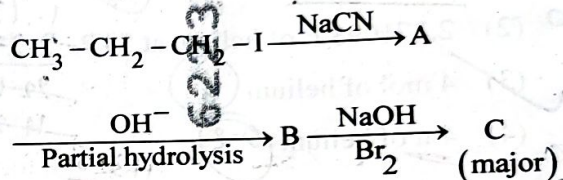

- (1) butanamide
- (2) α -bromobutanoic acid
- (3) propylamine
- (4) butylamine

95

The rate of a reaction quadruples when temperature changes from 27°C to 57°C . Calculate the energy of activation.

Given $R = 8.314 \text{ J K}^{-1} \text{ mol}^{-1}$, $\log 4 = 0.6021$

- (1) 3.80 kJ/mol
 - (2) 3804 kJ/mol
 - (3) 38.04 kJ/mol
 - (4) 380.4 kJ/mol
- [r] = 4 times*
27° → 57°
57° ΔT = 30°

96

Consider the following reaction in a sealed vessel at equilibrium with concentrations of $\text{N}_2 = 3.0 \times 10^{-3} \text{ M}$, $\text{O}_2 = 4.2 \times 10^{-3} \text{ M}$ and $\text{NO} = 2.8 \times 10^{-3} \text{ M}$.

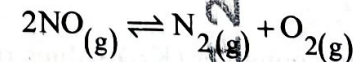

If 0.1 mol L^{-1} of $\text{NO}(\text{g})$ is taken in a closed vessel, what will be degree of dissociation (α) of $\text{NO}(\text{g})$ at equilibrium?

- (1) 0.8889
- (2) 0.717
- (3) 0.00889
- (4) 0.0889

97 The work done during reversible isothermal expansion of one mole of hydrogen gas at 25°C from pressure of 20 atmosphere to 10 atmosphere is:

(Given $R = 2.0 \text{ cal K}^{-1} \text{ mol}^{-1}$)

- (1) 413.14 calories -
- (2) 100 calories ✓
- (3) 0 calorie ✗
- (4) -413.14 calories ✗

98 Mass in grams of copper deposited by passing 9.6487 A current through a voltmeter containing copper sulphate solution for 100 seconds is:

(Given : Molar mass of Cu : 63 g mol^{-1} , $1F = 96487 \text{ C}$)

- (1) 31.5 g ✓
- (2) 0.0315 g ✗
- (3) 3.15 g -
- (4) 0.315 g -

Major products A and B formed in the following reaction sequence, are

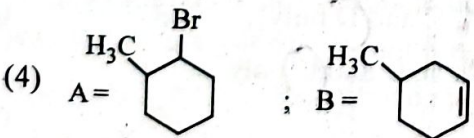
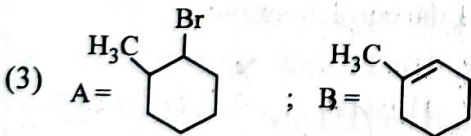
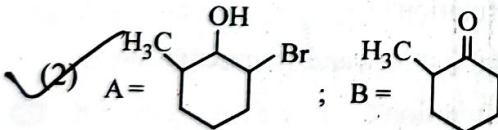
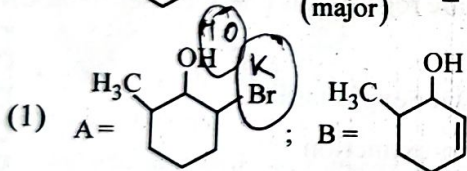
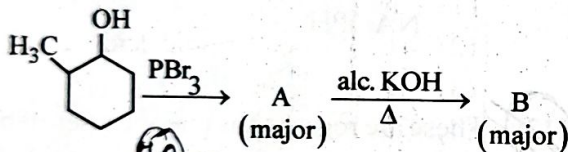

101 Identify the set of correct statements:

- ✓ A. The flowers of *Vallisneria* are colourful and produce nectar. water
- ✓ B. The flowers of waterlily are not pollinated by water.
- ✓ C. In most of water-pollinated species, the pollen grains are protected from wetting.
- ✓ D. Pollen grains of some hydrophytes are long and ribbon like.
- ✓ E. In some hydrophytes, the pollen grains are carried passively inside water.

Choose the correct answer from the options given below:

- (1) ✗ C, D and E only
- ✓ (2) B, C, D and E only
- (3) C, D and E only
- (4) ✗ B, C and D only

102 The type of conservation in which the threatened species are taken out from their natural habitat and placed in special setting where they can be protected and given special care is called;

- (1) Semi-conservative method ✓
- (2) Sustainable development ✓
- (3) *in-situ* conservation ✗
- (4) Biodiversity conservation

103 Inhibition of Succinic dehydrogenase enzyme by malonate is a classical example of:

- ✓ (1) Competitive inhibition
- (2) Enzyme activation
- (3) Cofactor inhibition
- (4) Feedback inhibition ✗

104 Identify the part of the seed from the given figure which is destined to form root when the seed germinates.

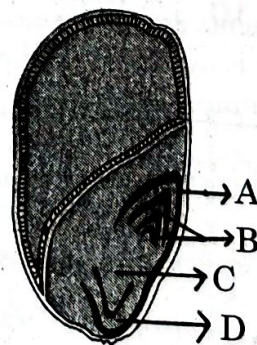

- (1) C
- (3) A
- ✓ (2) D
- (4) B

100 The pair of lanthanoid ions which are diamagnetic is

- (1) Gd^{3+} and Eu^{3+}
- (2) Pm^{3+} and Sm^{3+}
- (3) Ce^{4+} and Yb^{2+}
- (4) Ce^{3+} and Eu^{2+}

even, except for odd e^- $10e^-$ $16e^-$

- 105 Bulliform cells are responsible for
- (1) Increased photosynthesis in monocots. ✓
 - ✓ (2) Providing large spaces for storage of sugars.
 - (3) Inward curling of leaves in monocots. ✗
 - (4) Protecting the plant from salt stress. ✗

106 Which of the following are required for the dark reaction of photosynthesis?

- A. Light
- B. Chlorophyll
- C. CO₂
- D. ATP ✓
- E. NADPH ✓

Choose the correct answer from the options given below:

- (1) C, D and E only
- ✓ (2) D and E only
- (3) A, B and C only
- (4) B, C and D only

107 Formation of interfascicular cambium from fully developed parenchyma cells is an example for

- (1) Dedifferentiation ✓
- (2) Maturation ✗
- (3) Differentiation ✗
- ✓ (4) Redifferentiation

108 Hind II always cuts DNA molecules at a particular point called recognition sequence and it consists of:

- (1) 4 bp
- (2) 10 bp
- (3) 8 bp
- ✓ (4) 6 bp

109 Tropical regions show greatest level of species richness because

- ✓ A. Tropical latitudes have remained relatively undisturbed for millions of years, hence more time was available for species diversification.
- ✓ B. Tropical environments are more seasonal.
- C. More solar energy is available in tropics.
- D. Constant environments promote niche specialization.
- E. Tropical environments are constant and predictable.

Choose the correct answer from the options given below:

- (1) A, B and E only ✗
- (2) A, B and D only
- (3) A, C, D and E only ✗
- ✓ (4) A and B only

110 Which one of the following is not a criterion for classification of fungi?

- ✓ (1) Mode of spore formation
- ✓ (2) Fruiting body
- ✓ (3) Morphology of mycelium
- ✓ (4) Mode of nutrition

111 How many molecules of ATP and NADPH are required for every molecule of CO₂ fixed in the Calvin cycle?

- (1) 3 molecules of ATP and 3 molecules of NADPH
- (2) 3 molecules of ATP and 2 molecules of NADPH
- ✓ (3) 2 molecules of ATP and 3 molecules of NADPH
- (4) 2 molecules of ATP and 2 molecules of NADPH

112 These are regarded as major causes of biodiversity loss:

- ✓ A. Over exploitation
- ✓ B. Co-extinction
- ✗ C. Mutation
- ✓ D. Habitat loss and fragmentation
- ✗ E. Migration

Choose the correct option:

- (1) A, B and E only ✗
- ✓ (2) A, B and D only
- (3) A, C and D only
- ✗ (4) A, B, C and D only

113 The capacity to generate a whole plant from any cell of the plant is called:

- (1) Differentiation ✗
- (2) Somatic hybridization ✗
- ✓ (3) Totipotency
- (4) Micropropagation

114 The equation of Verhulst-Pearl logistic growth is

$$\frac{dN}{dt} = rN \left[\frac{K-N}{K} \right]$$

From this equation, K indicates:

- (1) Carrying capacity
- (2) Population density
- (3) Intrinsic rate of natural increase
- (4) Biotic potential

115 Spindle fibers attach to kinetochores of chromosomes during

- (1) Anaphase
- (2) Telophase
- (3) Prophase
- (4) Metaphase

116 Identify the type of flowers based on the position of calyx, corolla and androecium with respect to the ovary from the given figures (a) and (b)

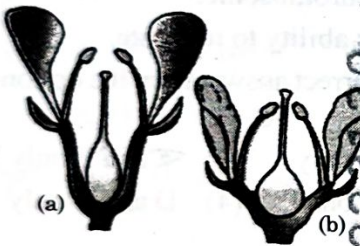

- (1) (a) Perigynous; (b) Epigynous
- (2) (a) Perigynous; (b) Perigynous
- (3) (a) Epigynous; (b) Hypogynous
- (4) (a) Hypogynous; (b) Epigynous

117 Match List I with List II

List I

- A. *Rhizopus*
- B. *Ustilago*
- C. *Puccinia*
- D. *Agaricus*

List II

- I. Mushroom
- II. Smut fungus
- III. Bread mould
- IV. Rust fungus

Choose the correct answer from the options given below:

- (1) A-III, B-II, C-I, D-IV
- (2) A-IV, B-III, C-II, D-I
- (3) A-III, B-II, C-IV, D-I
- (4) A-I, B-III, C-II, D-IV

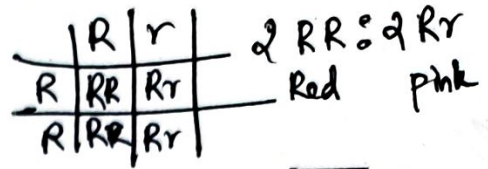

118 In a plant, black seed color (BB/Bb) is dominant over white seed color (bb). In order to find out the genotype of the black seed plant, with which of the following genotype will you cross it?

- (1) Bb
- (2) BB/Bb
- (3) BB
- (4) bb

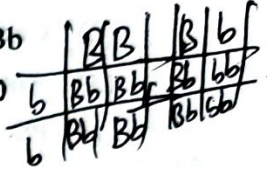

119 A pink flowered Snapdragon plant was crossed with a red flowered Snapdragon plant. What type of phenotype/s is/are expected in the progeny?

- (1) Only pink flowered plants
- (2) Red, Pink as well as white flowered plants
- (3) Only red flowered plants
- (4) Red flowered as well as pink flowered plants

120 Match List I with List II

List I

- A. Two or more alternative forms of a gene
- B. Cross of F₁ progeny with homozygous recessive parent
- C. Cross of F₁ progeny with any of the parents
- D. Number of chromosome sets in plant

List II

- I. Back cross
- II. Ploidy
- III. Allele
- IV. Test cross

Choose the correct answer from the options given below:

- (1) A-III, B-IV, C-I, D-II
- (2) A-IV, B-III, C-II, D-I
- (3) A-I, B-II, C-III, D-IV
- (4) A-II, B-I, C-III, D-IV

121 Lecithin, a small molecular weight organic compound found in living tissues, is an example of:

- (1) Glycerides
- (2) Carbohydrates
- (3) Amino acids
- (4) Phospholipids

122 Match List I with List II

- | List I | List II |
|------------------------------------|-------------------|
| A. <i>Clostridium butylicum</i> | I. Ethanol |
| B. <i>Saccharomyces cerevisiae</i> | II. Streptokinase |
| C. <i>Trichoderma polysporum</i> | III. Butyric acid |
| D. <i>Streptococcus</i> sp. | IV. Cyclosporin-A |

Choose the correct answer from the options given below:

- (1) A-III, B-I, C-IV, D-II
- (2) A-IV, B-I, C-III, D-II
- (3) A-III, B-I, C-II, D-IV
- (4) A-II, B-IV, C-III, D-I

123 In the given figure, which component has thin outer walls and highly thickened inner walls?

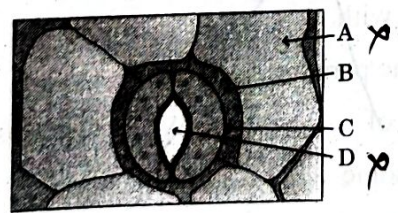

- (1) A
- (2) B
- (3) C
- (4) D

124 Which of the following is an example of actinomorphic flower?

- (1) *Pisum*
- (2) *Sesbania*
- (3) *Datura*
- (4) *Cassia*

125 A transcription unit in DNA is defined primarily by the three regions in DNA and these are with respect to upstream and downstream end;

- (1) Inducer, Repressor, Structural gene
- (2) Promotor, Structural gene, Terminator
- (3) Repressor, Operator gene, Structural gene
- (4) Structural gene, Transposons, Operator gene

126 What is the fate of a piece of DNA carrying a gene of interest which is transferred into an alien organism?

- A. The piece of DNA would be able to multiply itself independently in the progeny cells of the organism.
- B. It may get integrated into the genome of the recipient.
- C. It may multiply and be inherited along with the host DNA.
- D. The alien piece of DNA is not an integral part of chromosome.
- E. It shows ability to replicate.

Choose the correct answer from the options given below:

- (1) B and C only
- (2) A and E only
- (3) A and B only
- (4) D and E only

127 Auxin is used by gardeners to prepare weed-free lawns. But no damage is caused to grass as auxin

- (1) does not affect mature monocotyledonous plants.
- (2) can help in cell division in grasses, to produce growth.
- (3) promotes apical dominance.
- (4) promotes abscission of mature leaves only

128 The cofactor of the enzyme carboxypeptidase is

- (1) Flavin
- (2) Haem
- (3) Zinc
- (4) Niacin

129 The lactose present in the growth medium of bacteria is transported to the cell by the action of

- (1) Permease
- (2) Polymerase
- (3) Beta-galactosidase
- (4) Acetylase

130 Which one of the following can be explained on the basis of Mendel's Law of Dominance?

- A. Out of one pair of factors one is dominant and the other is recessive. ✓
- B. Alleles do not show any expression and both the characters appear as such in F₂ generation. ✗
- C. Factors occur in pairs in normal diploid plants. ✓
- D. The discrete unit controlling a particular character is called factor. ✓
- E. The expression of only one of the parental characters is found in a monohybrid cross. ✓

Choose the correct answer from the options given below:

- (1) B, C and D only
- (2) A, B, C, D and E
- (3) A, B and C only
- ✓ (4) A, C, D and E only

131 Given below are two statements:

✓ **Statement I :** Bt toxins are insect group specific and coded by a gene *cry* IAC.

✗ **Statement II :** Bt toxin exists as inactive protoxin in *B. thuringiensis*. However, after ingestion by the insect the inactive protoxin gets converted into active form due to acidic pH of the insect gut. alkaline

In the light of the above statements, choose the correct answer from the options given below:

- ✓ (1) Statement I is true but Statement II is false
- (2) Statement I is false but Statement II is true
- (3) Both Statement I and Statement II are true
- (4) Both Statement I and Statement II are false

132 Given below are two statements:

✓ **Statement I :** Parenchyma is living but collenchyma is dead tissue.

✓ **Statement II :** Gymnosperms lack xylem vessels but presence of xylem vessels is the characteristic of angiosperms.

In the light of the above statements, choose the correct answer from the options given below:

- (1) Statement I is true but Statement II is false
- ✓ (2) Statement I is false but Statement II is true
- (3) Both Statement I and Statement II are true
- ✓ (4) Both Statement I and Statement II are false

133 Given below are two statements:

✓ **Statement I :** Chromosomes become gradually visible under light microscope during leptotene stage. ✓

✓ **Statement II :** The beginning of diplotene stage is recognized by dissolution of synaptonemal complex. ✓

In the light of the above statements, choose the correct answer from the options given below:

- (1) Statement I is true but Statement II is false
- (2) Statement I is false but Statement II is true
- ✓ (3) Both Statement I and Statement II are true
- (4) Both Statement I and Statement II are false

134 Match List I with List II

List I

- A. Nucleolus
- B. Centriole
- C. Leucoplasts
- D. Golgi apparatus

List II

- I. Site of formation of glycolipid
- II. Organization like the cartwheel
- III. Site for active ribosomal RNA synthesis
- IV. For storing nutrients

Choose the correct answer from the options given below:

- (1) A-III, B-IV, C-II, D-I
- (2) A-I, B-II, C-III, D-IV
- ✓ (3) A-III, B-II, C-IV, D-I
- (4) A-II, B-III, C-I, D-IV

135 List of endangered species was released by-

- (1) FOAM
- (2) IUCN
- ✓ (3) GEAC
- (4) WWF

Botany : Section-B (Q. No. 136 to 150)

136 The DNA present in chloroplast is:

- (1) Linear, single stranded
- (2) Circular, single stranded
- (3) Linear, double stranded
- (4) Circular, double stranded

137 Which of the following are fused in somatic hybridization involving two varieties of plants?

- (1) Protoplasts
- (2) Pollens
- (3) Callus
- (4) Somatic embryos

138 Identify the correct description about the given figure:



- (1) Cleistogamous flowers showing autogamy.
- (2) Compact inflorescence showing complete autogamy.
- (3) Wind pollinated plant inflorescence showing flowers with well exposed stamens.
- (4) Water pollinated flowers showing stamens with mucilaginous covering.

139 Spraying sugarcane crop with which of the following plant growth regulators, increases the length of stem, thus, increasing the yield?

- (1) Cytokinin
- (2) Abscisic acid
- (3) Auxin
- (4) Gibberellin

140 Match List I with List II

List I

- A. Frederick Griffith
- B. Francois Jacob & Jacques Monod
- C. Har Gobind Khorana
- D. Meselson & Stahl

List II

- I. Genetic code
- II. Semi-conservative mode of DNA replication
- III. Transformation
- IV. Lac operon

Choose the correct answer from the options given below:

- (1) A-II, B-III, C-IV, D-I
- (2) A-IV, B-I, C-II, D-III
- (3) A-III, B-II, C-I, D-IV
- (4) A-III, B-IV, C-I, D-II

141 Match List I with List II

List I

- A. GLUT-4
- B. Insulin
- C. Trypsin
- D. Collagen

List II

- I. Hormone
- II. Enzyme
- III. Intercellular ground substance
- IV. Enables glucose transport into cell

Choose the correct answer from the options given below:

- (1) A-II, B-III, C-IV, D-I
- (2) A-III, B-IV, C-I, D-II
- (3) A-IV, B-I, C-II, D-III
- (4) A-I, B-II, C-III, D-IV

142 Given below are two statements:

Statement I : In C_3 plants, some O_2 binds RuBisCO, hence CO_2 fixation is decreased.

Statement II : In C_4 plants, mesophyll cells show very little photorespiration while bundle sheath cells do not show photorespiration.

In the light of the above statements, choose the correct answer from the options given below:

- (1) Statement I is true but Statement II is false
- (2) Statement I is false but Statement II is true
- (3) Both Statement I and Statement II are true
- (4) Both Statement I and Statement II are false

$GPP - R = NPP$

- 143 Identify the step in tricarboxylic acid cycle, which does not involve oxidation of substrate.
- (1) Succinyl-CoA → Succinic acid
 - (2) Isocitrate → α-ketoglutaric acid
 - (3) Malic acid → Oxaloacetic acid
 - (4) Succinic acid → Malic acid

- 146 In an ecosystem if the Net Primary Productivity (NPP) of first trophic level is

$100x \text{ (kcal m}^{-2}\text{) yr}^{-1}$, what would be the GPP (Gross Primary Productivity) of the third trophic level of the same ecosystem?

- (1) $10x \text{ (kcal m}^{-2}\text{) yr}^{-1}$ 1st → 100x
- (2) $\frac{100x}{3x} \text{ (kcal m}^{-2}\text{) yr}^{-1}$ 3rd → ? 300x
- (3) $\frac{x}{10} \text{ (kcal m}^{-2}\text{) yr}^{-1}$ 3 × 100x
- (4) $x \text{ (kcal m}^{-2}\text{) yr}^{-1}$

144 Match List I with List II

- | List I | List II |
|------------------------------|--|
| A. Citric acid cycle | I. Cytoplasm |
| B. Glycolysis | II. Mitochondrial matrix |
| C. Electron transport system | III. Intermembrane space of mitochondria |
| D. Proton gradient | IV. Inner mitochondrial membrane |

Choose the correct answer from the options given below:

- (1) A-III, B-IV, C-I, D-II
- (2) A-IV, B-III, C-II, D-I
- (3) A-I, B-II, C-III, D-IV
- (4) A-II, B-I, C-IV, D-III

147 Match List I with List II

- | List I | List II |
|-----------|---------------------------|
| A. Rose | I. Twisted aestivation |
| B. Pea | II. Perigynous flower |
| C. Cotton | III. Drupe |
| D. Mango | IV. Marginal placentation |

Choose the correct answer from the options given below:

- (1) A-IV, B-III, C-II, D-I
- (2) A-II, B-III, C-IV, D-I
- (3) A-II, B-IV, C-I, D-III
- (4) A-I, B-II, C-III, D-IV

148 Match List I with List II

- | List I | List II |
|---------------------------|---|
| A. Robert May | I. Species-Area relationship |
| B. Alexander von Humboldt | II. Long term ecosystem experiment using out door plots |
| C. Paul Ehrlich | III. Global species diversity at about 7 million |
| D. David Tilman | IV. Rivet popper hypothesis |

Choose the correct answer from the options given below:

- (1) A-I, B-III, C-II, D-IV
- (2) A-III, B-IV, C-II, D-I
- (3) A-II, B-III, C-I, D-IV
- (4) A-III, B-I, C-IV, D-II

- 145 Which of the following statement is correct regarding the process of replication in *E.coli*?

- (1) The DNA dependent DNA polymerase catalyses polymerization in 5' → 3' as well as 3' → 5' direction.
- (2) The DNA dependent DNA polymerase catalyses polymerization in 5' → 3' direction.
- (3) The DNA dependent DNA polymerase catalyses polymerization in one direction that is 3' → 5'.
- (4) The DNA dependent RNA polymerase catalyses polymerization in one direction, that is 5' → 3'.

149 Match List I with List II

List I	List II
(Types of Stamens)	(Example)
A. Monoadelphous	I. Citrus
B. Diadelphous	II. Pea
C. Polyadelphous	III. Lily
D. Epiphyllous	IV. China-rose

Choose the correct answer from the options given below:

- (1) A-I, B-II, C-IV, D-III
- (2) A-III, B-I, C-IV, D-II
- (3) A-IV, B-II, C-I, D-III
- (4) A-IV, B-I, C-II, D-III

150 Read the following statements and choose the set of correct statements

In the members of Phaeophyceae,

- A. Asexual reproduction occurs usually by biflagellate zoospores.
- B. Sexual reproduction is by oogamous method only.
- C. Stored food is in the form of carbohydrates which is either mannitol or laminarin.
- D. The major pigments found are chlorophyll a, c and carotenoids and xanthophyll.
- E. Vegetative cells have a cellulosic wall, usually covered on the outside by gelatinous coating of algin.

Choose the correct answer from the options given below:

- (1) A, C, D and E only
- (2) A, B, C and E only
- (3) A, B, C and D only
- (4) B, C, D and E only

151 Match List I with List II :

List I	List II
A. Typhoid	I. Fungus
B. Leishmaniasis	II. Nematode
C. Ringworm	III. Protozoa
D. Filariasis	IV. Bacteria

Choose the correct answer from the options given below :

- (1) A-III, B-I, C-IV, D-II
- (2) A-II, B-IV, C-III, D-I
- (3) A-I, B-III, C-II, D-IV
- (4) A-IV, B-III, C-I, D-II

152 Match List I with List II :

List I	List II
A. Non-medicated IUD	I. Multiload 375
B. Copper releasing IUD	II. Progestogens
C. Hormone releasing IUD	III. Lippes loop
D. Implants	IV. LNG-20

Choose the correct answer from the options given below :

- (1) A-IV, B-I, C-II, D-III
- (2) A-III, B-I, C-IV, D-II
- (3) A-III, B-I, C-II, D-IV
- (4) A-I, B-III, C-IV, D-II

153 Given below are two statements :

Statement I : The presence or absence of hymen is not a reliable indicator of virginity.

Statement II : The hymen is torn during the first coitus only.

In the light of the above statements, choose the correct answer from the options given below :

- (1) Statement I is true but Statement II is false
- (2) Statement I is false but Statement II is true
- (3) Both Statement I and Statement II are true
- (4) Both Statement I and Statement II are false

154 In both sexes of cockroach, a pair of jointed filamentous structures called anal cerci are present on :

- (1) 8th and 9th segment
- (2) 11th segment
- (3) 5th segment
- (4) 10th segment

55 Match List I with List II :

- | List I | List II |
|-----------------|--|
| A. Pons | I. Provides additional space for Neurons, regulates posture and balance. |
| B. Hypothalamus | II. Controls respiration and gastric secretions. |
| C. Medulla | III. Connects different regions of the brain. |
| D. Cerebellum | IV. Neuro secretory cells |

Choose the correct answer from the options given below :

- (1) A-I, B-III, C-II, D-IV
- (2) A-II, B-I, C-III, D-IV
- (3) A-II, B-III, C-I, D-IV
- (4) A-III, B-IV, C-II, D-I

156 Which of the following is not a steroid hormone?

- (1) Progesterone
- (2) Glucagon
- (3) Cortisol
- (4) Testosterone

157 Which one is the correct product of DNA dependent RNA polymerase to the given template?

3'TACATGGCAAATATCCATTCA5'

- (1) 5'AUGUACCGUUUAUAGGGAAGU3'
- (2) 5'ATGTACCGTTTATAGGTAAGT3'
- (3) 5'AUGUACCGUUUAUAGGUAAGU3'
- (4) 5'AUGUAAAGUUUAUAGGUAAGU3'

158 Three types of muscles are given as a, b and c. Identify the correct matching pair along with their location in human body :



(a) skeletal (b) smooth (c) Cardiac
Name of muscle/location

- (1) (a) Skeletal - Biceps
- (b) Involuntary - Intestine
- (c) Smooth - Heart.
- (2) (a) Involuntary - Nose tip
- (b) Skeletal - Bone
- (c) Cardiac - Heart.
- (3) (a) Smooth - Toes
- (b) Skeletal - Legs
- (c) Cardiac - Heart.
- (4) (a) Skeletal - Triceps
- (b) Smooth - Stomach
- (c) Cardiac - Heart.

159 Following are the stages of cell division :

- A. Gap 2 phase
- B. Cytokinesis
- C. Synthesis phase
- D. Karyokinesis
- E. Gap 1 phase

Choose the correct sequence of stages from the options given below :

- (1) B-D-E-A-C
- (2) E-C-A-D-B
- (3) C-E-D-A-B
- (4) E-B-D-A-C

160 Which of the following are Autoimmune disorders?

- A. Myasthenia gravis
- B. Rheumatoid arthritis
- C. Gout
- D. Muscular dystrophy
- E. Systemic Lupus Erythematosus (SLE)

Choose the most appropriate answer from the options given below :

- (1) B, C & E only
- (2) C, D & E only
- (3) A, B & D only
- (4) A, B & E only

161 Match List I with List II :

- | List I | List II |
|-------------|-------------------------|
| A. Lipase | I. Peptide bond |
| B. Nuclease | II. Ester bond |
| C. Protease | III. Glycosidic bond |
| D. Amylase | IV. Phosphodiester bond |

Choose the correct answer from the options given below :

- (1) A-II, B-IV, C-I, D-III
 (2) A-IV, B-I, C-III, D-II
 (3) A-IV, B-II, C-III, D-I
 (4) A-III, B-II, C-I, D-IV

162 The flippers of the Penguins and Dolphins are the example of the

- (1) Convergent evolution
 (2) Divergent evolution
 (3) Adaptive radiation
 (4) Natural selection

163 Match List I with List II :

- | List I | List II |
|---------------------------------|--|
| A. Expiratory capacity | I. Expiratory reserve volume + Tidal volume + $ERV+TV+IRV$ |
| B. Functional residual capacity | II. Tidal volume + Expiratory reserve volume $ERV+TV$ |
| C. Vital capacity | III. Tidal volume + Inspiratory reserve volume $IRV+TV$ |
| D. Inspiratory capacity | IV. Expiratory reserve volume + Residual volume $ERV+RV$ |

Choose the correct answer from the options given below :

- (1) A-II, B-I, C-IV, D-III
 (2) A-I, B-III, C-II, D-IV
 (3) A-II, B-IV, C-I, D-III
 (4) A-III, B-II, C-IV, D-I

164 Which one of the following factors will not affect the Hardy-Weinberg equilibrium?

- (1) Gene migration
 (2) Constant gene pool
 (3) Genetic recombination
 (4) Genetic drift

165

Given below are some stages of human evolution. Arrange them in correct sequence. (Past to Recent)

- A. Homo habilis
 B. Homo sapiens
 C. Homo neanderthalensis
 D. Homo erectus

Choose the correct sequence of human evolution from the options given below :

- (1) C-B-D-A
 (2) A-D-C-B
 (3) D-A-C-B
 (4) B-A-D-C

166

Following are the stages of pathway for conduction of an action potential through the heart:

- A. AV bundle
 B. Purkinje fibres
 C. AV node
 D. Bundle branches
 E. SA node

ECADB

Choose the correct sequence of pathway from the options given below :

- (1) B-D-E-C-A
 (2) E-A-D-B-C
 (3) E-C-A-D-B
 (4) A-E-C-B-D

167

Which of the following factors are favourable for the formation of oxyhaemoglobin in alveoli?

- (1) Low pCO_2 and High H^+ concentration
 (2) Low pCO_2 and High temperature
 (3) High pO_2 and High pCO_2
 (4) High pO_2 and Lesser H^+ concentration

168

Match List I with List II :

- | List I | List II |
|-------------------------------|--------------------|
| A. α -1 antitrypsin | I. Cotton bollworm |
| B. Cry IAb | II. ADA deficiency |
| C. Cry IAc | III. Emphysema |
| D. Enzyme replacement therapy | IV. Corn borer |

Choose the correct answer from the options given below :

- (1) A-III, B-IV, C-I, D-II
 (2) A-II, B-IV, C-I, D-III
 (3) A-II, B-I, C-IV, D-III
 (4) A-III, B-I, C-II, D-IV

169 Given below are two statements : one is labelled as Assertion A and the other is labelled as Reason R :

Assertion A : FSH acts upon ovarian follicles in female and Leydig cells in male.

Reason R : Growing ovarian follicles secrete estrogen in female while interstitial cells secrete androgen in male human being.

In the light of the above statements, choose the correct answer from the options given below :

- (1) A is true but R is false
- (2) A is false but R is true
- (3) Both A and R are true and R is the correct explanation of A.
- (4) Both A and R are true but R is NOT the correct explanation of A.

170 The following diagram showing restriction sites in *E. coli* cloning vector pBR322. Find the role of 'X' and 'Y' genes :

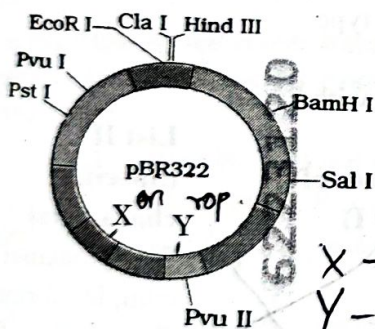

X - ori
Y - rop

- (1) The gene 'X' is for protein involved in replication of Plasmid and 'Y' for resistance to antibiotics.
- (2) Gene 'X' is responsible for recognition sites and 'Y' is responsible for antibiotic resistance.
- (3) The gene 'X' is responsible for resistance to antibiotics and 'Y' for protein involved in the replication of Plasmid.
- (4) The gene 'X' is responsible for controlling the copy number of the linked DNA and 'Y' for protein involved in the replication of Plasmid.

171 Match List I with List II :

List I		List II
A. Cocaine	I	Effective sedative in surgery
B. Heroin	II	<i>Cannabis sativa</i>
C. Morphine	III	<i>Erythroxylum</i>
D. Marijuana	IV	<i>Papaver somniferum</i>

Choose the correct answer from the options given below :

- (1) A-II, B-I, C-III, D-IV
- (2) A-III, B-IV, C-I, D-II
- (3) A-IV, B-III, C-I, D-II
- (4) A-I, B-III, C-II, D-IV

172 Consider the following statements :

- A. Annelids are true coelomates ✓
- B. Poriferans are pseudocoelomates ✗
- C. Aschelminthes are acoelomates ✗
- D. Platyhelminthes are pseudocoelomates ✗

Choose the correct answer from the options given below :

- (1) C only
- (2) D only
- (3) B only
- (4) A only

173 Given below are two statements :

Statement I : In the nephron, the descending limb of loop of Henle is impermeable to water and permeable to electrolytes.

Statement II : The proximal convoluted tubule is lined by simple columnar brush border epithelium and increases the surface area for reabsorption.

In the light of the above statements, choose the correct answer from the options given below :

- (1) Statement I is true but Statement II is false
- (2) Statement I is false but Statement II is true
- (3) Both Statement I and Statement II are true
- (4) Both Statement I and Statement II are false

174 Match List I with List II :

- | List I | | List II |
|---------------------------|------|--|
| A. Fibrous joints | I. | Adjacent vertebrae, limited movement |
| B. Cartilaginous joints | II. | Humerus and Pectoral girdle, rotational movement |
| C. Hinge joints | III. | Skull, don't allow any movement |
| D. Ball and socket joints | IV. | Knee, help in locomotion |

Choose the correct answer from the options given below :

- (1) A-II, B-III, C-I, D-IV
- (2) A-III, B-I, C-IV, D-II
- (3) A-IV, B-II, C-III, D-I
- (4) A-I, B-III, C-II, D-IV

175 Which of the following is not a natural/traditional contraceptive method?

- (1) Lactational amenorrhea
- (2) Vaults
- (3) Coitus interruptus
- (4) Periodic abstinence

176 Match List I with List II :

- | List I | | List II |
|------------------|------|--------------|
| A. Pleurobrachia | I. | Mollusca |
| B. Radula | II. | Ctenophora |
| C. Stomochord | III. | Osteichthyes |
| D. Air bladder | IV. | Hemichordata |

Choose the correct answer from the options given below :

- (1) A-II, B-IV, C-I, D-III
- (2) A-IV, B-III, C-II, D-I
- (3) A-IV, B-II, C-III, D-I
- (4) A-II, B-I, C-IV, D-III

177 Match List I with List II :

- | List I | | List II |
|----------------------|------|--------------------|
| A. Axoneme | I. | Centriole |
| B. Cartwheel pattern | II. | Cilia and flagella |
| C. Crista | III. | Chromosome |
| D. Satellite | IV. | Mitochondria |

Choose the correct answer from the options given below :

- (1) A-II, B-IV, C-I, D-III
- (2) A-II, B-I, C-IV, D-III
- (3) A-IV, B-III, C-II, D-I
- (4) A-IV, B-II, C-III, D-I

178 Which of the following statements is incorrect?

- (1) Bio-reactors are used to produce small scale bacterial cultures.
- (2) Bio-reactors have an agitator system, an oxygen delivery system and foam control system.
- (3) A bio-reactor provides optimal growth conditions for achieving the desired product.
- (4) Most commonly used bio-reactors are of stirring type.

179 Match List I with List II :

- | List I
(Sub Phases of Prophase I) | | List II
(Specific characters) |
|--------------------------------------|------|--|
| A. Diakinesis | I. | Synaptonemal complex formation |
| B. Pachytene | II. | Completion of terminalisation of chiasmata |
| C. Zygotene | III. | Chromosomes look like thin threads |
| D. Leptotene | IV. | Appearance of recombination nodules |

Choose the correct answer from the options given below :

- (1) A-II, B-IV, C-I, D-III
- (2) A-IV, B-III, C-II, D-I
- (3) A-IV, B-II, C-III, D-I
- (4) A-I, B-II, C-IV, D-III

180 Match List I with List II :

List I

- A. Common cold
 B. Haemozoin
 C. Widal test
 D. Allergy

List II

- I. *Plasmodium*
 II. Typhoid
 III. Rhinoviruses
 IV. Dust mites

Choose the correct answer from the options given below :

- (1) A-III, B-I, C-II, D-IV
 (2) A-IV, B-II, C-III, D-I
 (3) A-II, B-IV, C-III, D-I
 (4) A-I, B-III, C-II, D-IV

181 Given below are two statements : one is labelled as Assertion A and the other is labelled as Reason R :

Assertion A : Breast-feeding during initial period of infant growth is recommended by doctors for bringing a healthy baby.

Reason R : Colostrum contains several antibodies absolutely essential to develop resistance for the new born baby.

In the light of the above statements, choose the most appropriate answer from the options given below :

- (1) A is correct but R is not correct.
 (2) A is not correct but R is correct.
 (3) Both A and R are correct and R is the correct explanation of A.
 (4) Both A and R are correct but R is NOT the correct explanation of A.

182 Match List I with List II :

List I

- A. *Pterophyllum*
 B. *Myxine*
 C. *Pristis*
 D. *Exocoetus*

List II

- I. Hag fish
 II. Saw fish
 III. Angel fish
 IV. Flying fish

Choose the correct answer from the options given below :

- (1) A-IV, B-I, C-II, D-III
 (2) A-III, B-II, C-I, D-IV
 (3) A-II, B-I, C-III, D-IV
 (4) A-III, B-I, C-II, D-IV

183

The "Ti plasmid" of *Agrobacterium tumefaciens* stands for

- (1) Tumor inducing plasmid
 (2) Temperature independent plasmid
 (3) Tumour inhibiting plasmid
 (4) Tumor independent plasmid

184

Which of the following is not a component of Fallopian tube?

- (1) Infundibulum
 (2) Ampulla
 (3) Uterine fundus
 (4) Isthmus

185

Match List I with List II :

List I

- A. Down's syndrome
 B. α -Thalassemia
 C. β -Thalassemia
 D. Klinefelter's syndrome

List II

- I. 11th chromosome
 II. 'X' chromosome
 III. 21st chromosome
 IV. 16th chromosome

Choose the correct answer from the options given below :

- (1) A-III, B-IV, C-I, D-II
 (2) A-IV, B-I, C-II, D-III
 (3) A-I, B-II, C-III, D-IV
 (4) A-II, B-III, C-IV, D-I

Zoology : Section-B (Q. No. 186 to 200)

186 The following are the statements about non-chordates :

- A. Pharynx is perforated by gill slits. ✓
- B. Notochord is absent. ✓
- C. Central nervous system is dorsal.
- D. Heart is dorsal if present. ✓
- E. Post anal tail is absent. ✓

Choose the most appropriate answer from the options given below :

- (1) B, D & E only
- (2) B, C & D only
- (3) A & C only ✗
- (4) A, B & D only

187 Match List I with List II :

List I

List II

- | | |
|--------------------|------------------------|
| A. Mesozoic Era | I. Lower invertebrates |
| B. Proterozoic Era | II. Fish & Amphibia |
| C. Cenozoic Era | III. Birds & Reptiles |
| D. Paleozoic Era | IV. Mammals |

Choose the correct answer from the options given below :

- (1) A-I, B-II, C-IV, D-III
- (2) A-III, B-I, C-IV, D-II
- (3) A-II, B-I, C-III, D-IV ✓
- (4) A-III, B-I, C-II, D-IV

188 Given below are two statements :

Statement I : The cerebral hemispheres are connected by nerve tract known as corpus callosum. ✓

Statement II : The brain stem consists of the medulla oblongata, pons and cerebrum. ✗

In the light of the above statements, choose the most appropriate answer from the options given below :

- (1) Statement I is correct but Statement II is incorrect. ✓
- (2) Statement I is incorrect but Statement II is correct.
- (3) Both Statement I and Statement II are correct.
- (4) Both Statement I and Statement II are incorrect.

189 Identify the correct option (A), (B), (C), (D) with respect to spermatogenesis.

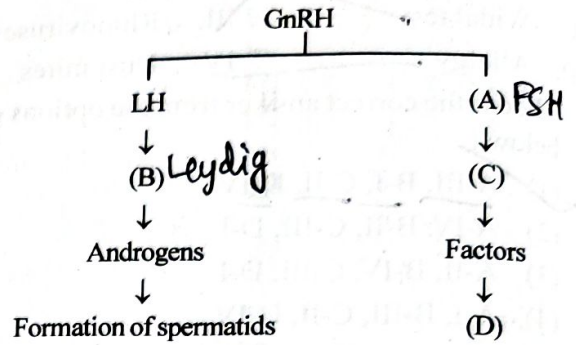

- (1) FSH, Sertoli cells, Leydig cells, spermatogenesis.
- (2) ICSH, Leydig cells, Sertoli cells, spermatogenesis. ✗
- (3) FSH, Leydig cells, Sertoli cells, spermiogenesis. ✓
- (4) ICSH, Interstitial cells, Leydig cells, spermiogenesis. ✗

190 Match List I with List II :

List I

List II

- | | |
|---------------------------------|------------------|
| A. RNA polymerase III | I. snRNPs |
| B. Termination of transcription | II. Promotor |
| C. Splicing of Exons | III. Rho factor |
| D. TATA box | IV. SnRNAs, tRNA |

Choose the correct answer from the options given below :

- (1) A-III, B-IV, C-I, D-II
- (2) A-IV, B-III, C-I, D-II
- (3) A-II, B-IV, C-I, D-III
- (4) A-III, B-II, C-IV, D-I

Match List I with List II :

List I

- A. Exophthalmic goiter
- B. Acromegaly
- C. Cushing's syndrome
- D. Cretinism

List II

- I. Excess secretion of cortisol, moon face & hyperglycemia
- II. Hypo-secretion of thyroid hormone and stunted growth.
- III. Hyper secretion of thyroid hormone & protruding eye balls.
- IV. Excessive secretion of growth hormone.

Choose the correct answer from the options given below :

- (1) A-III, B-IV, C-II, D-I
- (2) A-III, B-IV, C-I, D-II
- (3) A-I, B-III, C-II, D-IV
- (4) A-IV, B-II, C-I, D-III

Match List I with List II :

List I

List II

- A. Unicellular glandular epithelium
- B. Compound epithelium
- C. Multicellular glandular epithelium
- D. Endocrine glandular epithelium

- I. Salivary glands
- II. Pancreas
- III. Goblet cells of alimentary canal
- IV. Moist surface of buccal cavity

Choose the correct answer from the options given below :

- (1) A-III, B-IV, C-I, D-II
- (2) A-II, B-I, C-IV, D-III
- (3) A-II, B-I, C-III, D-IV
- (4) A-IV, B-III, C-I, D-II

193 Given below are two statements :

Statement I : Bone marrow is the main lymphoid organ where all blood cells including lymphocytes are produced.

Statement II : Both bone marrow and thymus provide micro environments for the development and maturation of T-lymphocytes.

In the light of the above statements, choose the most appropriate answer from the options given below :

- (1) Statement I is correct but Statement II is incorrect.
- (2) Statement I is incorrect but Statement II is correct.
- (3) Both Statement I and Statement II are correct.
- (4) Both Statement I and Statement II are incorrect.

194 Match List I with List II related to digestive system of cockroach.

List I

List II

- A. The structures used for storing of food.
- B. Ring of 6-8 blind tubules at junction of foregut and midgut.
- C. Ring of 100-150 yellow coloured thin filaments at junction of midgut and hindgut.
- D. The structures used for grinding the food.

- I. Gizzard
- II. Gastric Caeca
- III. Malpighian tubules
- IV. Crop

Choose the correct answer from the options given below :

- (1) A-IV, B-III, C-II, D-I
- (2) A-III, B-II, C-IV, D-I
- (3) A-IV, B-II, C-III, D-I
- (4) A-I, B-II, C-III, D-IV

195

Choose the correct statement given below regarding juxta medullary nephron.

- (1) Loop of Henle of juxta medullary nephron runs deep into medulla.
- (2) Juxta medullary nephrons outnumber the cortical nephrons.
- (3) Juxta medullary nephrons are located in the columns of Bertini.
- (4) Renal corpuscle of juxta medullary nephron lies in the outer portion of the renal medulla.

196

Match List I with List II :

- | List I | List II |
|----------------|---|
| A. P wave | I. Heart muscles are electrically silent. |
| B. QRS complex | II. Depolarisation of ventricles. |
| C. T wave | III. Depolarisation of atria. |
| D. T-P gap | IV. Repolarisation of ventricles. |

Choose the correct answer from the options given below :

- (1) A-II, B-III, C-I, D-IV
- (2) A-IV, B-II, C-I, D-III
- (3) A-I, B-III, C-IV, D-II
- (4) A-III, B-II, C-IV, D-I

197

As per ABO blood grouping system, the blood group of father is B⁺, mother is A⁺ and child is O⁺. Their respective genotype can be

- A. I^Bi / I^Ai / ii
- B. I^BI^B / I^AI^A / ii
- C. I^AI^B / ii^A / I^Bi
- D. I^Ai / I^Bi / I^AI^A
- E. ii^B / ii^A / I^AI^B

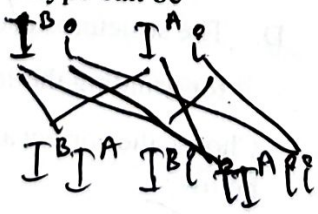

Choose the most appropriate answer from the options given below :

- (1) C & B only
- (2) D & E only
- (3) A only
- (4) B only

198

Given below are two statements :

Statement I : Gause's competitive exclusion principle states that two closely related species competing for different resources cannot exist indefinitely.

Statement II : According to Gause's principle during competition, the inferior will be eliminated. This may be true if resources are limiting.

In the light of the above statements, choose the correct answer from the options given below :

- (1) Statement I is true but Statement II is false.
- (2) Statement I is false but Statement II is true.
- (3) Both Statement I and Statement II are true.
- (4) Both Statement I and Statement II are false.

199

Regarding catalytic cycle of an enzyme action select the correct sequential steps :

- A. Substrate enzyme complex formation.
- B. Free enzyme ready to bind with another substrate.
- C. Release of products.
- D. Chemical bonds of the substrate broken.
- E. Substrate binding to active site.

Choose the correct answer from the options given below :

- (1) B, A, C, D, E
- (2) E, D, C, B, A
- (3) E, A, D, C, B
- (4) A, E, B, D, C

200

Given below are two statements :

Statement I : Mitochondria and chloroplasts are both double membrane bound organelles.

Statement II : Inner membrane of mitochondria is relatively less permeable, as compared to chloroplast.

In the light of the above statements, choose the most appropriate answer from the options given below :

- (1) Statement I is correct but Statement II is incorrect.
- (2) Statement I is incorrect but Statement II is correct.
- (3) Both Statement I and Statement II are correct.
- (4) Both Statement I and Statement II are incorrect.